



# HOSHIZAKI

## CERTIFICATION



HACCP International



ISO9001

## FM-300AKS-HCN-SB-B-301SA

### NUGGET ICE MAKER



## Key Features



NATURAL  
REFRIGERANTS

**Eco-Friendly  
Refrigerant**



**Easy for maintenance**  
Notify when parts should  
be replaced

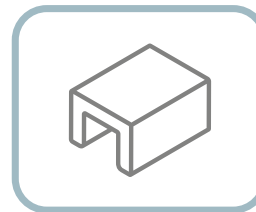

**Stainless Steel  
Exterior**

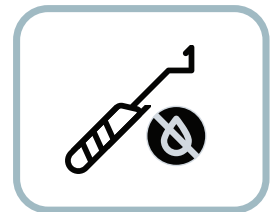

**Stainless Steel &  
Greaseless Auger**

Our Flake & Nugget Ice Makers belong to the true allrounders of the Hoshizaki product line-up. These powerful, durable and sustainable machines are highly popular across different market segments, such as in food preparation / processing, as well as in hotels, bars, restaurants and catering businesses.



# Dimensions & Specifications

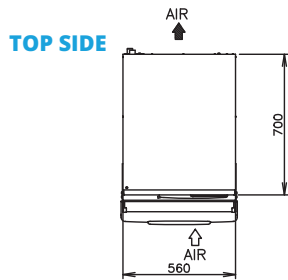

## NUGGET ICE AIR SYSTEM

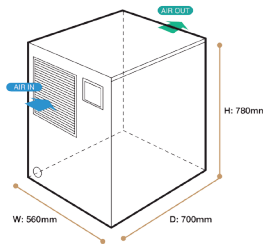

## ICE SHAPE

### NUGGET Compressed Flake Ice

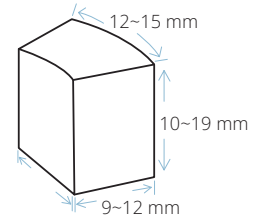

## FRONT SIDE

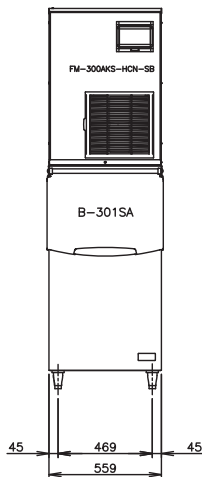

## RIGHT SIDE

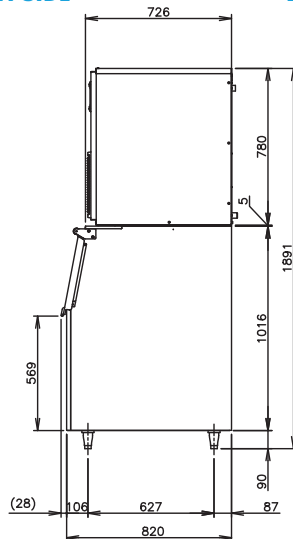

## BACK SIDE

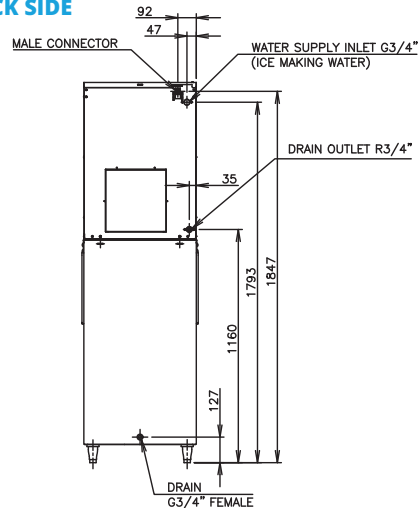

MODEL		FM-300AKS-HCN-SB-B-301SA
ICE SHAPE		Nugget Ice
POWER SUPPLY		1 Phase 220-240V 50Hz Capacity: 1.04kVA (4.7A)
AMPERAGE		4.7A Started: 16A
ELECTRIC CONSUMPTION		810W
HEAT REJECTION	(AT32°C / WT21°C)	1850W
ICE PRODUCTION PER 24H	(AT10°C / WT10°C)	275kg
	(AT21°C / WT15°C)	231kg
	(AT32°C / WT21°C)	189kg
STORAGE CAPACITY		Approx. 144kg
WATER CONSUMPTION PER 24H	(AT32°C / WT21°C)	187L
CONTAINER TYPE		Ice bin is not included
REFRIGERANT		R290 / 110g
OUTSIDE DIMENSIONS		560mm(W) x 820mm(D) x 1891( - 1921)mm(H)
PACKAGE		Ice Maker: Carton: 665 x 820 x 950mm Storage Bin: Carton: 655 x 924 x 1188mm
WEIGHT		Ice Maker: 80.5kg / 87.5kg Storage Bin: 37kg / 49kg
OPERATING CONDITIONS		Ambient Temp.:5-40°C, Water Supply Temp.:5-35°C, Water Supply Pressure: 0.05-0.8MPa, Voltage Range: Rated Voltage±10%



# HOSHIZAKI

## HOSHIZAKI VIETNAM CORPORATION

168/14 Nguyen Gia Tri, Thanh My Tay Ward, Ho Chi Minh City  
Vietnam 760000

TEL +84 0 916 161 346 <https://hoshizaki-sea.com/>

